

# Premium Rider Scrubbers

# v2.0

PILOT | GTX | GTR

# FACTORYCAT®

Handmade in U.S.A. - Est 1986



## Family-Owned & Operated



Scrubbers

Sweepers

# Choose Your Chassis



## Pilot v2.0 Specs

- Up to 140,000 sqft/Charge
- 22 / 23 Gallons
- 25 - 29 inch decks

## Applications

- Automotive Shops
- Machine Shops
- Warehouses



## GTX v2.0 Specs

- Up to 282,000 sqft/Charge
- 33 / 36 Gallons
- 25 - 34 inch decks

## Applications

- Fabrication Shops
- Beverage Distribution
- Food Packaging



## GTR v2.0 Specs

- Up to 280,000 sqft/Charge
- 46 / 49 Gallons
- 29 - 37 inch decks

## Applications

- Distribution
- Sports Arenas
- Aviation

# Choose Your Deck

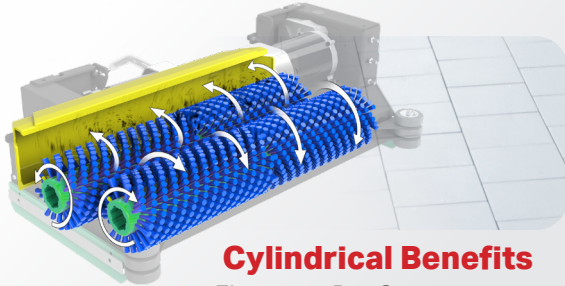

## Cylindrical Benefits

- Eliminates Pre-Sweeping
- Scrub & Sweep Simultaneously
- Superior Tile & Grout Cleaning
- Great for Indoor Track Fields

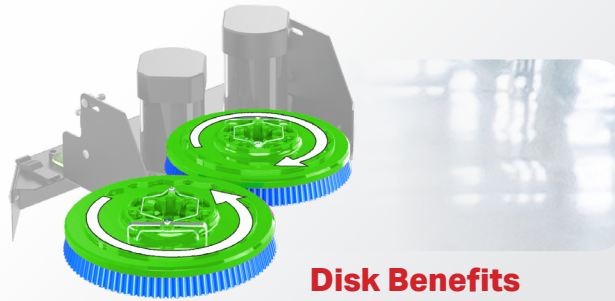

## Disk Benefits

- Largest Brush/ Pad Selection
- Lowest Maintenance Cost
- Best Performance on Irregular Floors
- Brushes Individually driven

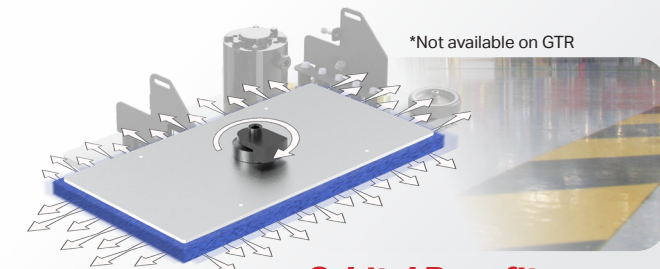

## Orbital Benefits

- Chemical Free Stripping
- Reduce Slip & Fall Potential
- 70% Reduction in Water Usage
- VCT Prep & Recoat

# Choose Your Controller

## Military Grade (Year 1970 Technology)



## Legacy (Year 2000 Technology)



## Touch Screen (Year 2010 Technology)



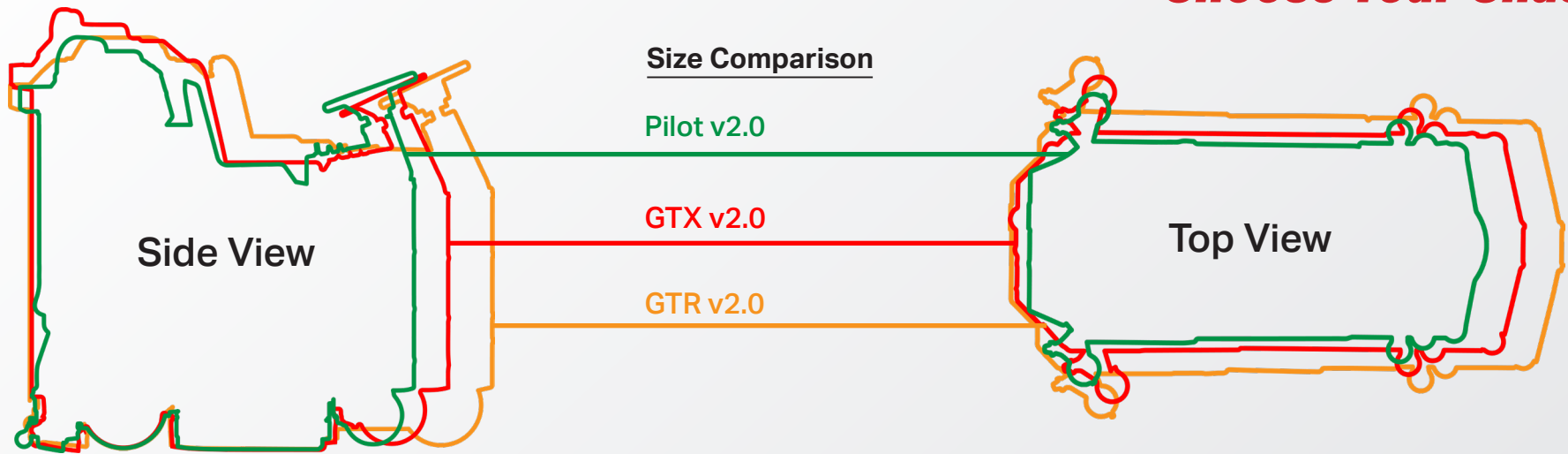

- ①\* Polypropylene: Black / Medium - Light
- ② Nylon: White / Light - Soft
- ③ Tampico: Tan / Soft
- ④\* Tufted Pad Driver: Red / Variety Pads
- ⑤\* Neoprene Pad Driver: Black / Variety Diamond Pucks
- ⑥\* Super Grit: Orange / Extreme Rough
- ⑦ Tough Grit: Black / Very Rough
- ⑧ Midi Grit: Blue / Rough
- ⑨ Light Grit: Grey / Medium

\*Not offered on Cylindrical Brushes

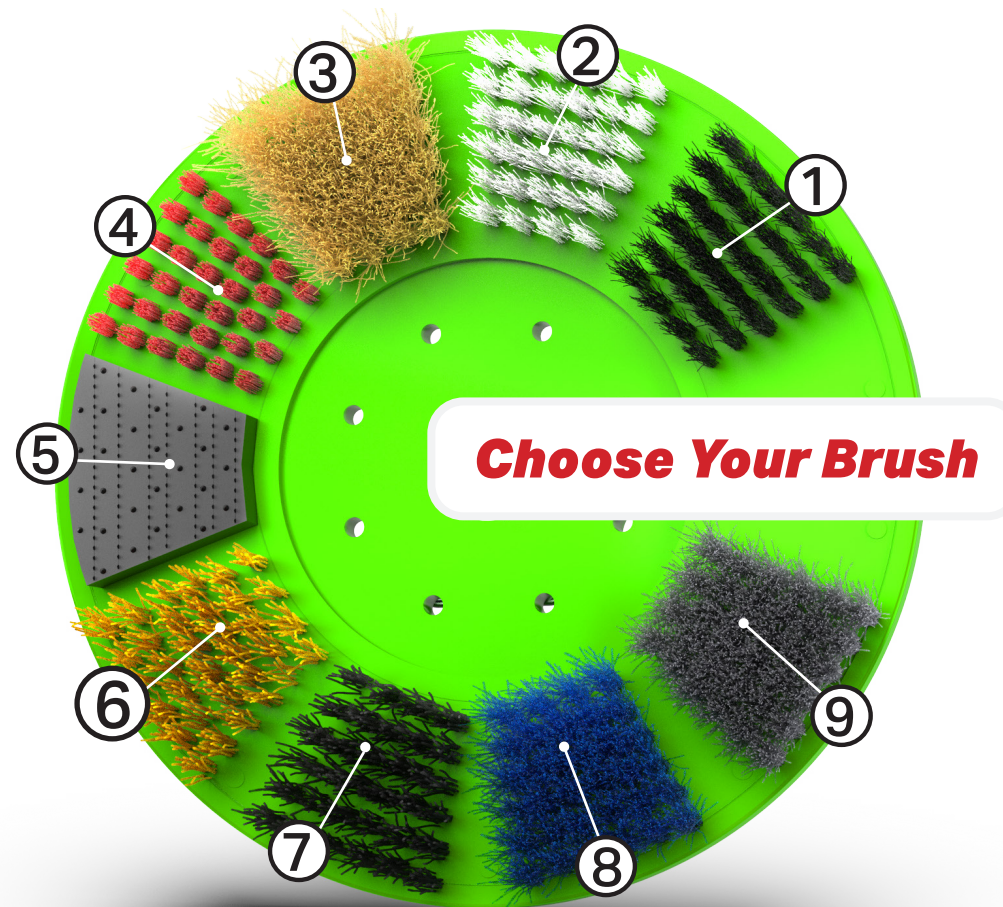

# View Inside

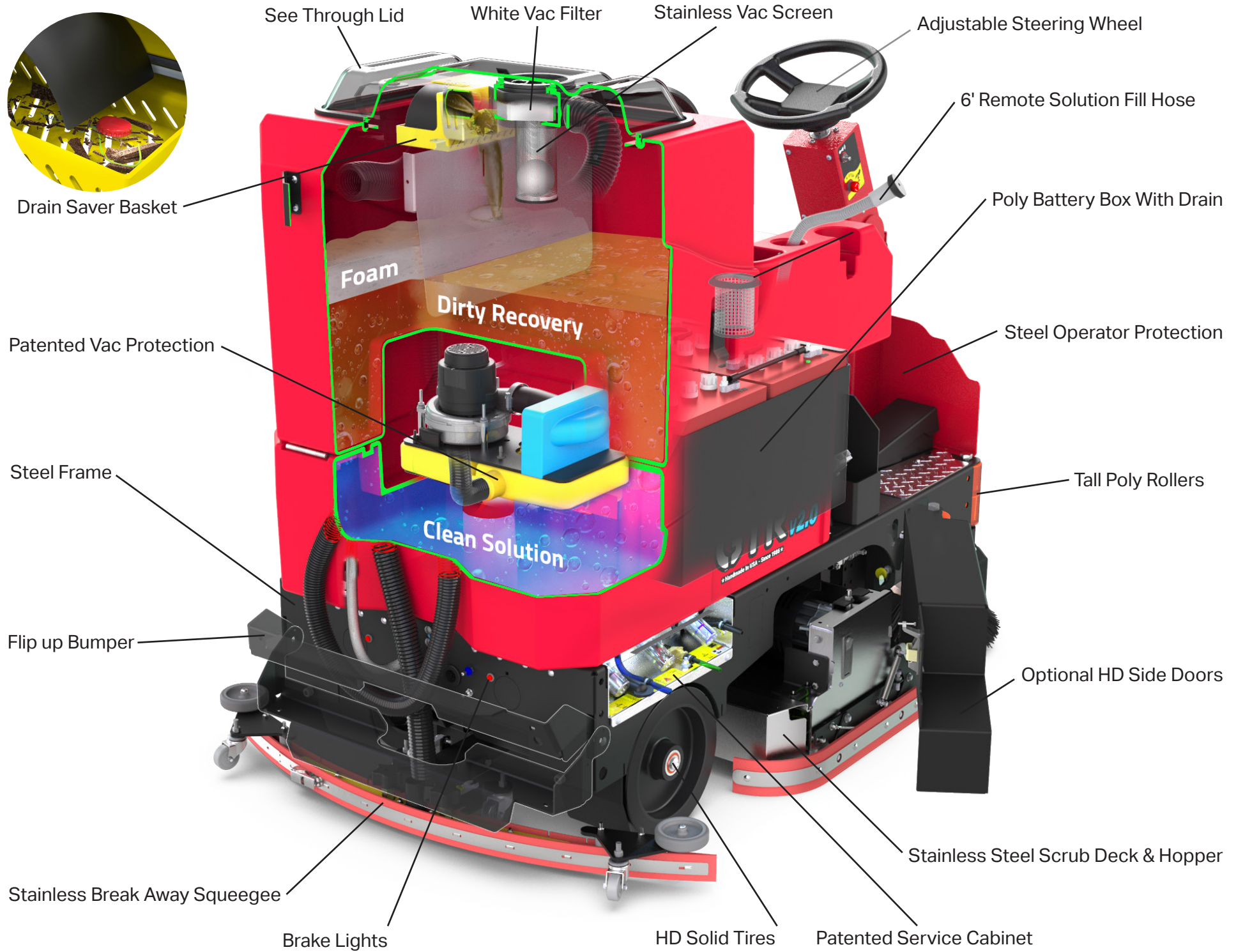
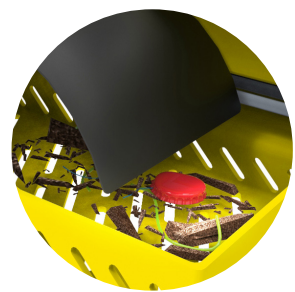



## Green Antimicrobial Tanks

Special plastic formula inhibits growth of bacteria and other harmful contaminants inside tanks. The vac motor on all scrubbers suck air through the recovery tank and therefore will dispense odors or contaminants back into the air everyone inhale inside the building.

- Almost 6,000 cubic feet/hour of airflow (size average classroom).

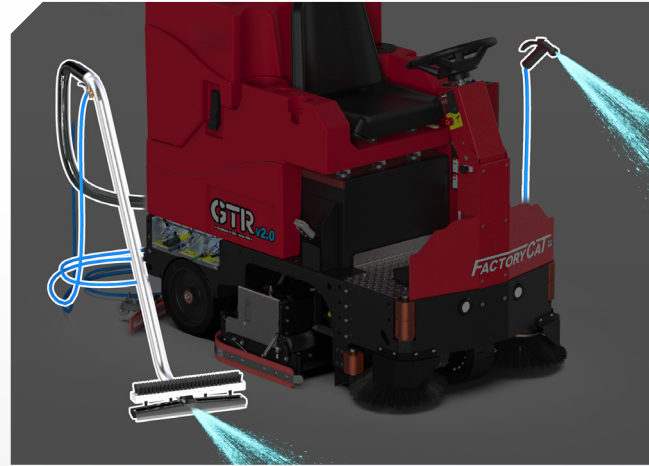

## Scrub And Vac Wand / Spray Jet

- Brush side for floor scrubbing
- Squeegee side for water pickup
- Clean restrooms and under tables
- Pre-soak the floor before scrubbing
- Rinse out the Recovery Tank

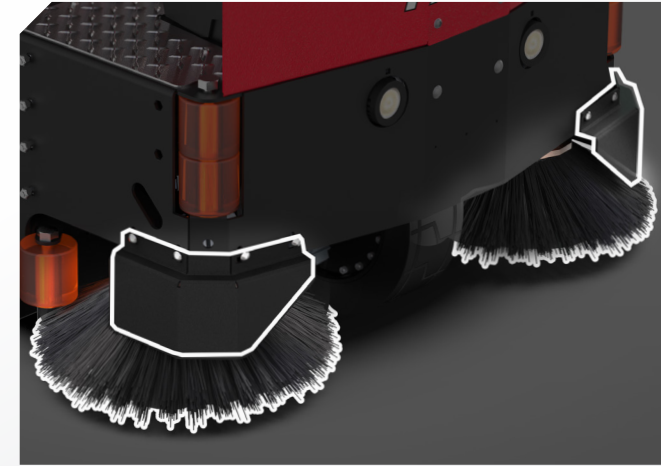

## Dual Side Brooms And Guards

Extends the cleaning path up to walls and racking pallets. Moving small debris to center of path reduces squeegee streaking and hose clogs.

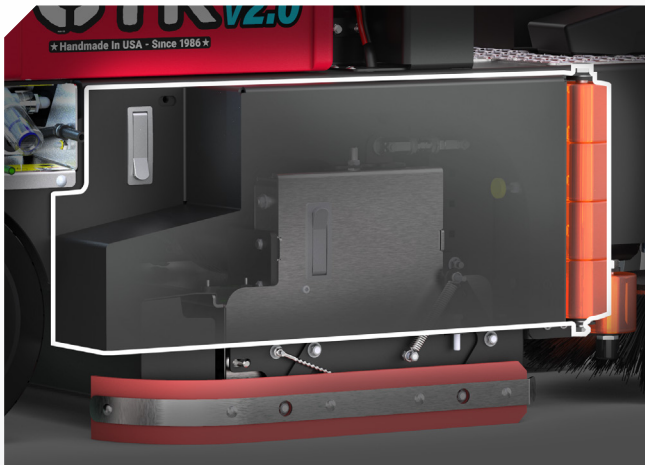

## Heavy Duty Side Doors

Thick Steel with leading rollers offers protection of critical scrub deck, reducing equipment damage and down time for repairs.



## Overhead Guard / Grey Tires

- Protects operator from falling objects\*  
\*Not available on all riders
- Optional non-marking Grey Tires

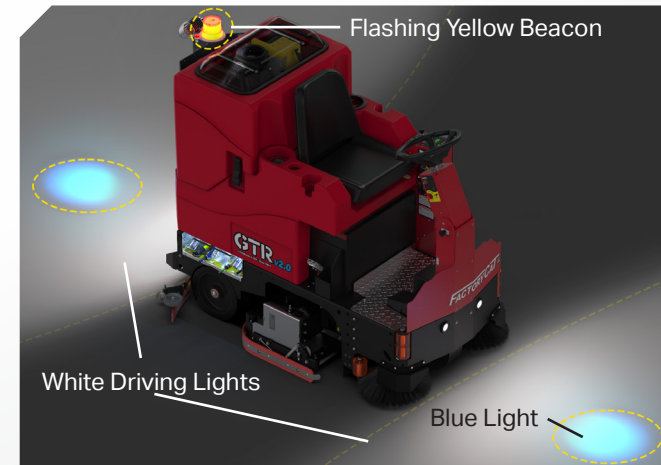

## Lights

- Traditional white flood lights ahead and behind increase visibility for the operator and oncoming traffic
- Blue spot light warns oncoming traffic and pedestrians in congested and noisy applications.
- Flashing Yellow Beacon

# You Be The Judge

Easy Access to key components:

- Vac Motor
- Batteries
- Deck Actuator
- Solution Valve
- Filters-Screens
- Soap Drain
- Battery Box Drain
- Unloader Valve
- Vac Switch
- Pumps



## Tip Back Tank

Our designers and engineers have 25+ years of experience and recognize cleaning equipment will eventually require service.

- Tanks tip back without tools, providing easy top side access to all important service items.
- Quick access allows the technician to trouble shoot from their feet and make repairs in less time, with less chance of creating unintended problems from disassembling multiple items to get to the single part that failed.



## Large Clear Lid

Any customer who has previously owned and operated cleaning equipment will appreciate the value of full time viewing of the dirty water recovery tank.

- This provides the operator with a real time view of the dirty water level, foam, debris tray, the vacuum's white dust filter and more.
- The fully accessible recovery tank is perhaps our most significant feature for cost reduction. Open the lid to clean out the recovery tank, eliminating odors and other contaminants which can become airborne and inhaled by employees.

## Steel Frame

We spend the extra time and money to through-bolt with stainless fasteners for longevity and service ease in the future. Some of our larger rider scrubbers have 750-lbs in batteries in a full height poly liner, supported by the steel frame.

- All assemblies mount directly to the 7-ga (3/16" thick) steel frame, instead of plastic parts that will fatigue in time.
- Accidental damage to bumpers, decks, wheels, or over tensioning the frame during transport will not damage our tanks since we don't bolt collision points to the poly tank.

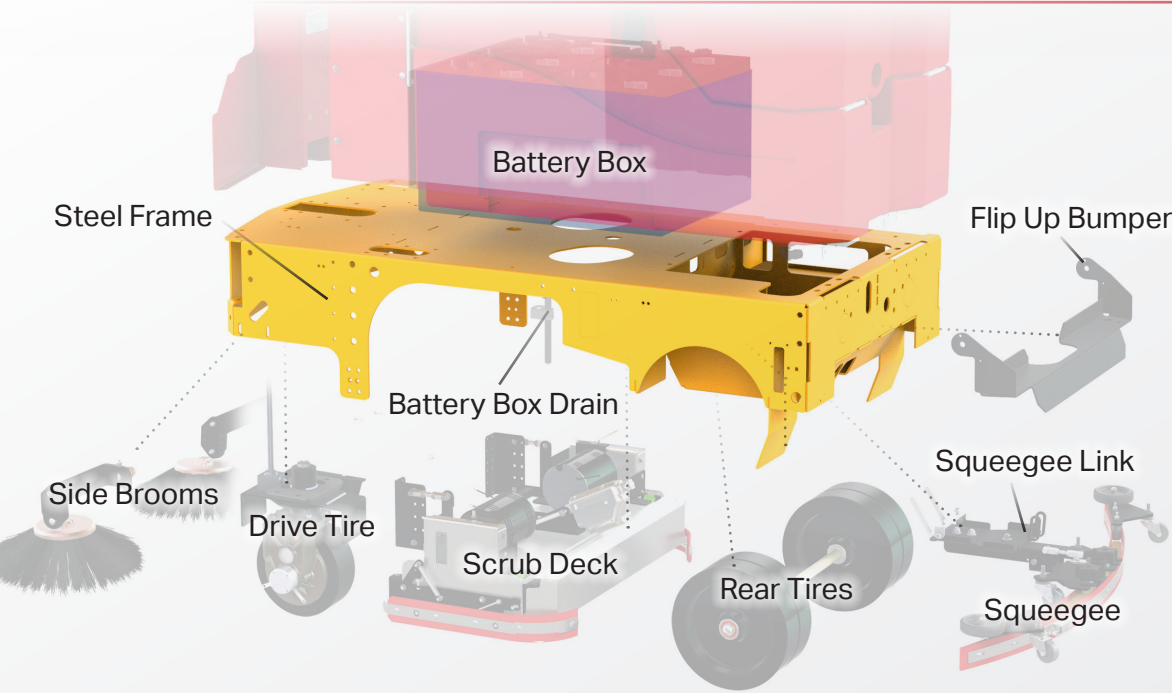

## Stainless Squeegee

- Parts exposed to recovery water are stainless steel
- Locking latches front and rear
- Range of material for different applications
- Smooth and Rough floor hole patterns

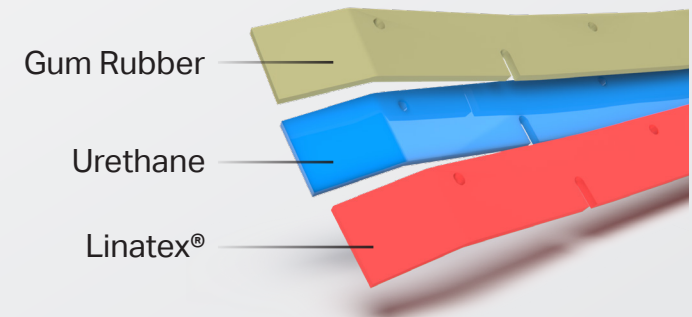
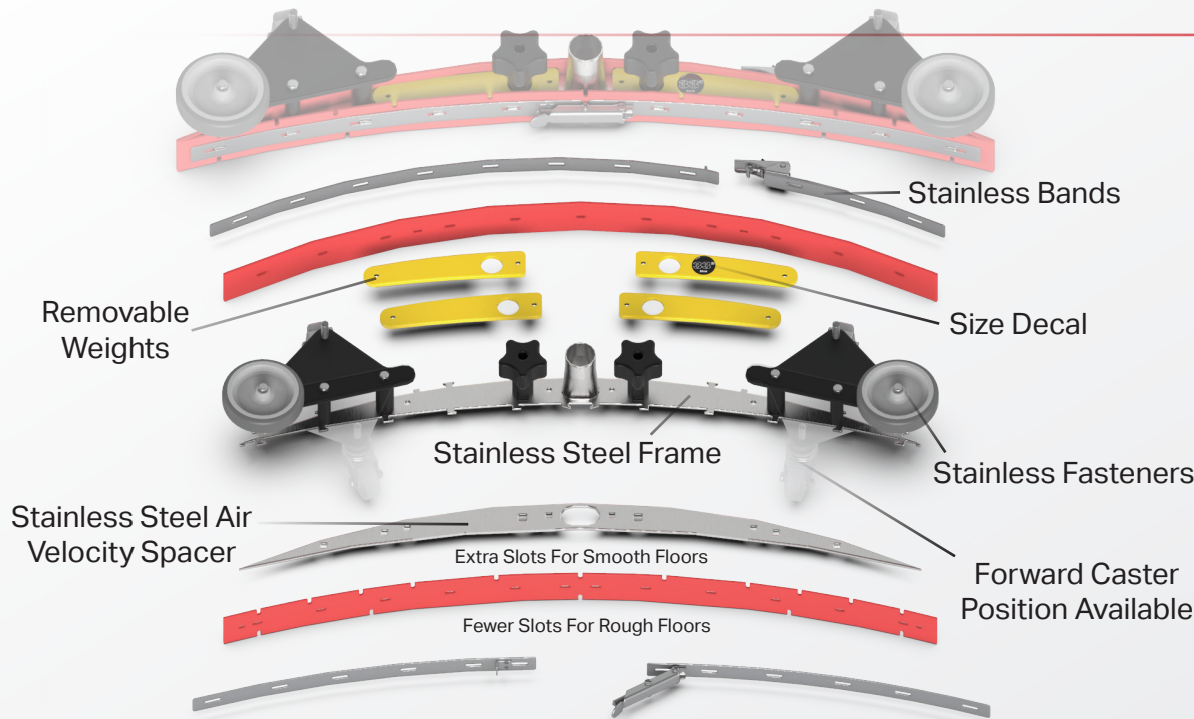

## You Be The Judge



## Baffle System

- The dirty water passes into our drain saver basket, and then fills up the rear side of the baffle such that the foam doesn't migrate to the front where the stainless screen and ball float operates.
- The stainless screen and white vacuum filter offer protection and ensure good airflow (squeegee performance).

## Patented Vac Box System

- This invention earned a US Patent. The Yellow Vac Box is vacuumized and safely stores up to 1-gallon of foam or dirty water away from the vac motor's intact.
- Dirty water drains out of the yellow vac box via Unloader valve as soon as vacuum is turned OFF.
- The blue muffler box reduces the noise and directs moisture out to the bowls, alerting the operator of a problem.

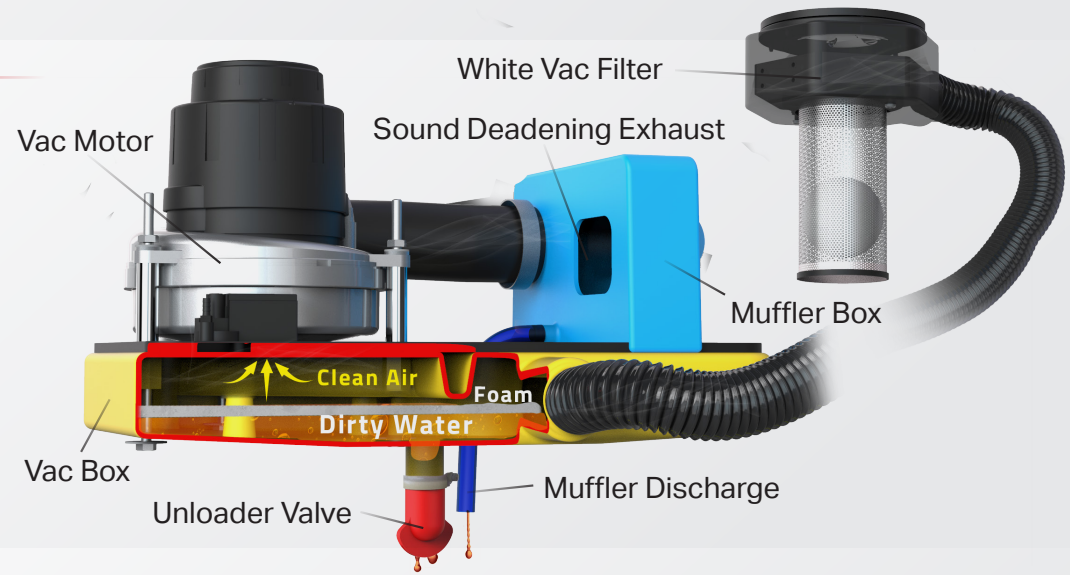

## Patented Service Cabinet

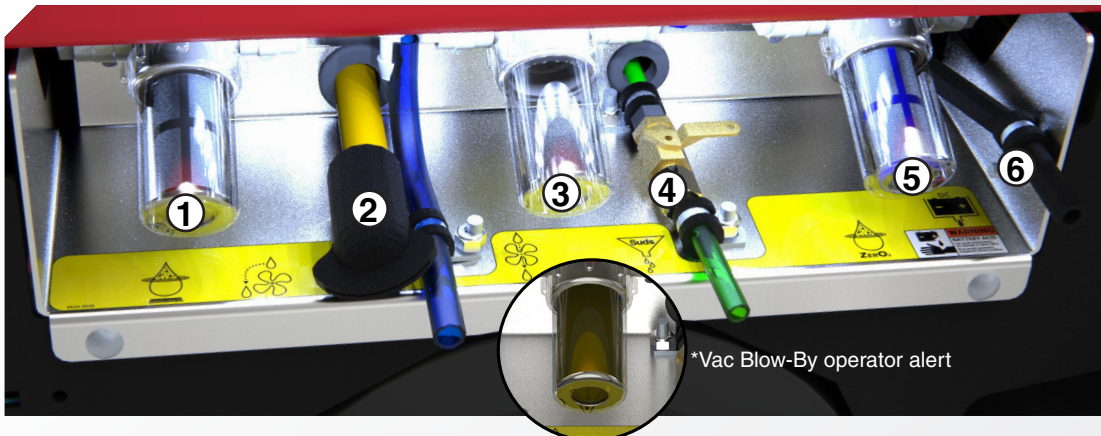

- ① Solution Filter: Screen fresh water to scrub deck
- ② Unloader Valve: Auto drains dirty water protecting Vac
- ③ Vac Blow-By: Collects vac moisture to alert operator
- ④ Suds Valve: Drain soap from Suds Reservoir
- ⑤ ZERO3 Filter: Screen Aqueous Ozone solution
- ⑥ Battery Box Valve: Drain excess electrolyte safely





## Automotive

Automotive dealerships and large Truck service centers are some of the toughest applications we've run across. Our equipment offers the maneuverability and performance to clean showrooms full of new cars on expensive floors. The same machine can survive use around steel car lifts, concrete edging and metal floor grates.



## Aviation

These customers appreciate reliability and quality as much as anyone. Our scrubbers collect floor debris and prevent FOD better than others, and the compact size combines productivity with good sight lines for operating close to expensive aircraft. Several aircraft manufacturers and FBO's trust our equipment to clean their assembly plants and service centers.



## Warehouse

Large distribution centers need maximum scrub path, tank capacities and run time, but in a footprint that allows for easy u-turns and cleaning close to racking. Our heavy duty products can withstand the expected collisions and have excellent water control so your stored product is protected. Our rider scrubbers offer superior productivity and durability.

# Applications



## Food & Beverage

Customers who deal with food and beverage manufacturing, processing and distribution appreciate our fully cleanable recovery tank and performance on the floor. Cleaning the reservoir that contains the dirty water eliminates bad odors and the transfer of various contaminants. Our optional onboard ozone system and remote hand tools takes this to an even higher level.



## Manufacturing

The process of cutting, welding, assembling and otherwise "building" stuff can be a tough application. Even with the latest production equipment it can be an environment demanding heavy duty products. Our equipment is built to take abuse and is easily serviced when necessary.



## Sports Arena

Applications that typically combine large open areas where productivity is important, with smaller aisles or elevators to access different locations. Our varied scrub head types and brushes allow customers broad flexibility for cleaning wood, tile, rubber, concrete, painted and other highly valued surfaces.



## Pilot v2.0

<b>BODY CONSTRUCTION / DIMENSIONS</b>	
Chassis Construction:	1/8" Steel (3.1 mm) Powder Coated
Front Wheels (Ø x Width)	8" x 3" (20 x 7 cm) - Solid Grey, Non-Marking
Rear Wheels (Ø x Width):	(2x) 12" x 3" ((2x) 30 x 7 cm) - Solid Black
Size (L x W x H):	53" x 31" x 57" (134 x 78 x 144 cm)
Weight (w/o Batteries):	525 - 575 lbs (238 - 261 kg)
Weight (w/ Batteries):	825 - 875 lbs (374 - 397 kg)
<b>BRUSH / PAD SYSTEM</b>	
Disk Dimensions:	26" - (2x) 13" Ø (66 - [2x] 33 cm) 28" - (2x) 14" Ø (71 - [2x] 35 cm)
Disk Motor:	(2x) 0.75 hp ((2x) 551 watts)
Disk Brush Speed:	270 rpm
Cylindrical Dimensions:	25" - (2x) 6" Ø x 23" (64 - [2x] 15 x 58 cm) 29" - (2x) 6" Ø x 27" (73 - [2x] 15 x 68 cm)
Cylindrical Motor:	(2x) 0.75 hp (2x) 551 watts
Cylindrical Brush Speed:	650 rpm Standard - 825 optional rpm
Orbital Dimensions:	24" x 14" (60 x 35 cm) 28" x 14" (71 x 35 cm)
Orbital Motor:	1.2 hp (882 watts) 2,500 rpm
Brush Down Pressure:	Up to 150 lbs (68 kg) / 500 lbs (227 kg) Actuator Rating
<b>POWER SYSTEM</b>	
System Voltage/Amps	36 VDC / 175 ah WET
Optional Battery:	Up to 225 ah WET / 200 ah AGM*
*Includes Onboard Charger	
Run Time:	Up to 3.5 Hours**
**Based on continuous scrubbing run times.	
<b>DRIVE SYSTEM</b>	
Power:	0.75 hp - All Gear / Sealed (559 watts)
Forward Speed:	0 - 320 ft/min / 0 - 3.6 mph (0 - 98 m/min / 0 - 6 km/h)
Scrubbing Speed:	0 - 256 ft/min / 0 - 2.9 mph (0 - 78 m/min / 0 - 5 km/h)
Reverse Speed:	0 - 230 ft/min / 0 - 2.6 mph (0 - 70 m/min / 0 - 4 km/h)
<b>SOLUTION / RECOVERY SYSTEMS</b>	
Solution Tank Capacity:	22 Gallons (83 liters) - w/ Graduated Site Tube
Solution Flow / Filter:	0 - 0.5 GPM / Stainless Inline (0 - 2 LPM)
Recovery Tank Capacity:	23 Gallons (87 liters) - 1.5" Ø Drain Hose
Demisting Chamber:	1.25 Gallons (4.7 liters)
Drain Saver:	130 cubic inches (2,130 cubic cm)
Vacuum Power	1.0 hp / 2 Stage / 6.6" Ø (745 watts)
(Water Lift / Airflow):	73" / 96 cfm (185 cm / 2.7 cm/m)
<b>GENERAL</b>	
Productivity - Theoretical:	Up to 40,000 sqft/hr (3,716 sqm)***
***Based off of ISSA 2010 Cleaning Times	
Productivity - Practical:	Up to 18,518 sqft/hr (1,720 sqm)***
***Based off of ISSA 2010 Cleaning Times	



## GTX v2.0

<b>BODY CONSTRUCTION / DIMENSIONS</b>	
Chassis Construction:	3/16" Steel (4.8 mm) Powder Coated
Front Wheels (Ø x Width)	10" x 3" (25 x 7 cm) - Solid Black
Rear Wheels (Ø x Width):	(2x) 12" x 3" ((2x) 30 x 7 cm) - Solid Black
Size (L x W x H):	66" x 34" x 64" (167 x 86 x 162 cm)
Weight (w/o Batteries):	725 lbs - 850 lbs (328 - 385 kg)
Weight (w/ Batteries):	1,195 - 1,325 lbs (542 - 601 kg)
<b>BRUSH / PAD SYSTEM</b>	
Disk Dimensions:	26" - (2x) 13" Ø (66 - [2x] 33 cm) 28" - (2x) 14" Ø (71 - [2x] 35 cm) 30" - (2x) 15" Ø (76 - [2x] 38 cm) 34" - (2x) 17" Ø (86 - [2x] 43 cm)
Disk Motor:	(2x) 0.75 hp ((2x) 551 watts)
Disk Brush Speed:	270 rpm
Optional Motor Upgrade:	(2x) 1.5 hp 350 rpm ((2x) 1,103 watts)
Cylindrical Dimensions:	25" - (2x) 6" Ø x 23" (63 - [2x] 15 x 58 cm) 29" - (2x) 6" Ø x 27" (73 - [2x] 15 x 68 cm) 33" - (2x) 6" Ø x 31" (83 - [2x] 15 x 78 cm)
Cylindrical Motor:	(2x) 0.75 hp ((2x) 551 watts)
Cylindrical Brush Speed:	650 rpm Standard - 825 optional rpm
Orbital Dimensions:	28" x 14" (71 x 35 cm) 32" x 14" (81 x 35 cm)
Orbital Motor:	1.2 hp (882 watts) 2,500 rpm
Brush Down Pressure:	Up to 200 lbs (90 kg) / 500 lbs (227 kg) Actuator Rating
<b>POWER SYSTEM</b>	
System Voltage/Amps	36 VDC / 210 ah WET
Optional Battery:	Up to 360 ah WET / 335 ah AGM*
*Includes Onboard Charger	
Run Time:	Up to 6 Hours**
**Based on continuous scrubbing run times.	
<b>DRIVE SYSTEM</b>	
Power:	0.75 hp - All Gear / Sealed (559 watts)
Forward Speed:	0 - 320 ft/min / 0 - 3.6 mph (0 - 98 m/min / 0 - 6 km/h)
Scrubbing Speed:	0 - 256 ft/min / 0 - 2.9 mph (0 - 78 m/min / 0 - 5 km/h)
Reverse Speed:	0 - 230 ft/min / 0 - 2.6 mph (0 - 70 m/min / 0 - 4 km/h)
<b>SOLUTION / RECOVERY SYSTEMS</b>	
Solution Capacity:	33 Gallons (125 liters) - w/ Graduated Site Tube
Solution Flow / Filter:	0 - 0.7 GPM / Stainless Inline (0 - 2 LPM)
Recovery Capacity:	36 Gallons (136 liters) - 1.5" Ø Drain Hose
Demisting Chamber:	1.25 Gallons (4.7 liters)
Drain Saver:	130 cubic inches (2,130 cubic cm)
Vacuum Power	1.0 hp / 2 Stage / 6.6" Ø (745 watts)
(Water Lift / Airflow):	73" / 96 cfm (185 cm / 2.7 cm/m)
<b>GENERAL</b>	
Productivity - Theoretical:	Up to 47,000 sqft/hr (4,366 sqm)***
***Based off of ISSA 2010 Cleaning Times	
Productivity - Practical:	Up to 21,661 sqft/hr (2,012 sqm)***
***Based off of ISSA 2010 Cleaning Times	



## GTR v2.0

<b>BODY CONSTRUCTION / DIMENSIONS</b>	
Chassis Construction:	3/16" Steel (4.8 mm) Powder Coated
Front Wheels (Ø x Width)	12" x 3" (30 x 7 cm) - Solid Black
Rear Wheels (Ø x Width):	(4x) 12" x 3" ((2x) 30 x 7 cm) - Solid Black
Size (L x W x H):	70" x 37" x 57" (177 x 93 x 144 cm)
Weight (w/o Batteries):	790 lbs - 914 lbs (358 - 414 kg)
Weight (w/ Batteries):	1,260 - 1,436 lbs (571 - 651 kg)
<b>BRUSH / PAD SYSTEM</b>	
Disk Dimensions:	30" - (2x) 15" Ø (76 - [2x] 38 cm) 34" - (2x) 17" Ø (86 - [2x] 43 cm) 36" - (2x) 18" Ø (91 - [2x] 45 cm)
Disk Motor:	(2x) 1.5 hp 350 rpm ((2x) 1,103 watts)
Disk Brush Speed:	350 rpm
Cylindrical Dimensions:	29" - (2x) 6" Ø x 27" (73 - [2x] 15 x 68 cm) 33" - (2x) 6" Ø x 31" (83 - [2x] 15 x 78 cm) 37" - (2x) 6" Ø x 35" (94 - [2x] 15 x 89 cm)
Cylindrical Motor:	(2x) 1.5 hp 350 rpm ((2x) 1,103 watts)
Cylindrical Brush Speed:	825 rpm
Orbital Dimensions:	N/A
Orbital Motor:	N/A
Brush Down Pressure:	Up to 225 lbs (102 kg) / 500 lbs (227 kg) Actuator Rating
<b>POWER SYSTEM</b>	
System Voltage/Amps	36 VDC / 310 ah WET
Optional Battery:	Up to 360 ah WET / 335 ah AGM*
*Includes Onboard Charger	
Run Time:	Up to 5.5 Hours**
**Based on continuous scrubbing run times.	
<b>DRIVE SYSTEM</b>	
Power:	2.0 hp - All Gear / Sealed (1,492 watts)
Forward Speed:	0 - 320 ft/min / 0 - 3.6 mph (0 - 98 m/min / 0 - 6 km/h)
Scrubbing Speed:	0 - 256 ft/min / 0 - 2.9 mph (0 - 78 m/min / 0 - 5 km/h)
Reverse Speed:	0 - 230 ft/min / 0 - 2.6 mph (0 - 70 m/min / 0 - 4 km/h)
<b>SOLUTION / RECOVERY SYSTEMS</b>	
Solution Capacity:	46 Gallons (174 liters) - w/ Graduated Site Tube
Solution Flow / Filter:	0 - 0.7 GPM / Stainless Inline (0 - 2 LPM)
Recovery Capacity:	49 Gallons (185 liters) - 1.5" Ø Drain Hose
Demisting Chamber:	1.25 Gallons (4.7 liters)
Drain Saver:	130 cubic inches (2,130 cubic cm)
Vacuum Power	1.0 hp / 2 Stage / 6.6" Ø (745 watts)
(Water Lift / Airflow):	73" / 96 cfm (185 cm / 2.7 cm/m)
<b>GENERAL</b>	
Productivity - Theoretical:	Up to 51,000 sqft/hr (4,738 sqm)***
***Based off of ISSA 2010 Cleaning Times	
Productivity - Practical:	Up to 23,627 sqft/hr (2,195 sqm)***
***Based off of ISSA 2010 Cleaning Times	

# Our Family's American Dream

RPS has been family owned from its inception in 1986, and proudly builds in Wisconsin (USA). The company has grown over the last 35-years with a strong group of executives including the 2nd generation of family owners who started in the shop as youngsters.



## Assembled By Hand

Our American workforce hand builds each machine with components sourced over 95% from American suppliers. We routinely pay more for these domestically supplied components required to build a superior product. All design, prototyping, production and testing is done in-house where we can best control quality.

Authorized Distributor



## Steel Fabrication

We produce heavy duty equipment and require a good amount of thick steel in the construction. We use a combination of Stainless 304 (Austenitic 18/8) and mild steel with e-coating + powder paint for corrosion resistance. Steel fabrication is done in-house or from local suppliers with specialty equipment.



## Rotational Molding

Complex shapes that allow for our "tank-in-tank" design are best achieved with in-house equipment. We own multiple dual station rotational molding machines that allow us to produce finished parts from raw plastic. Producing consistently higher quality parts, and respond quickly to sales spikes.

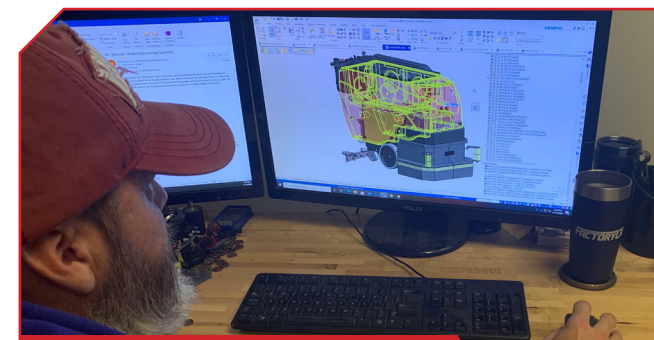

## Product Design

Our team has designed and engineered over 100 unique machines. Each new generation of machines evolve from prior designs to retain the strengths and correct any weakness. From the first pencil sketch we focus on durability, serviceability, performance, productivity, specifications, and value.